



## IMPROVE ACCURACY AND REDUCE COSTS

Specim FX10 camera series is designed for industrial and laboratory use. Specim FX10 cameras work in a line-scan mode in the visible and near-infrared (VNIR) area; Specim FX10 in the 400-1000 nm region, and the color optimized Specim FX10c camera in the 400-780 nm region.

Specim FX10 cameras are best suited for:

- Vegetation & agriculture
- Phenotyping
- Color & density in printing
- Display & light source inspection
- Food quality

## FEATURES

- Spectral range of 400-1000 / 400-780 nm
- High spatial resolution of 1024 pixels
- High image speed of 330 FPS (full range)
- Free wavelength selection from 224 bands within the camera coverage
- Built-in image correction
- Unified spectral calibration between units
- GigE or CameraLink standard interfaces
- Easy mounting to industrial environment

## SPECTRAL RESPONSE

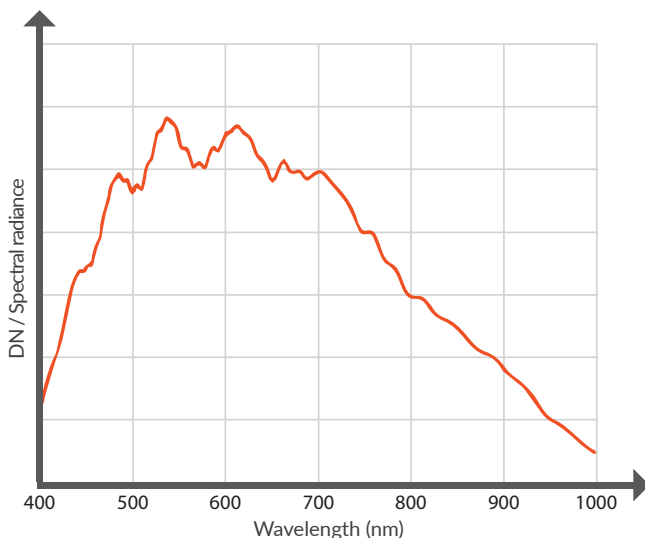

## DIMENSIONS

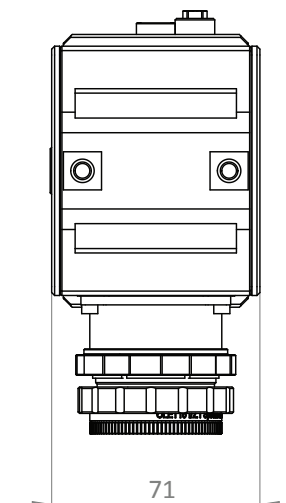
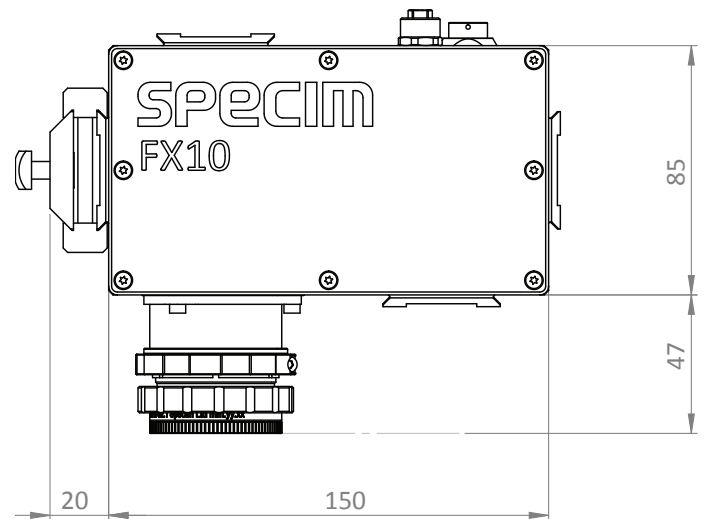

<b>Spectral Range</b>	400-1000 / 400-780 (c-version)	
<b>Spectral resolution (FWHM)</b>	5.5 nm (mean)	
<b>Spectral sampling/pixel</b>	2.7 nm	With default binning
<b>Spectral bands</b>	224 / 140 (c-version)	With default binning
<b>Numerical aperture</b>	1.7	With default lens
<b>Optics magnification</b>	0.80	
<b>Effective pixel size</b>	19.9x9.97 $\mu$ m	At fore lens image plane
<b>Effective slit width</b>	42 $\mu$ m	At fore lens image plane
<b>Effective slit length</b>	10.2 mm	At fore lens image plane
<b>SNR @ max. signal</b>	420 : 1	
<b>Spatial samples</b>	1024	
<b>Bit depth</b>	12	
<b>Maximum frame rate</b>	327 FPS full range / 514 FPS full range (c-version)	
<b>Binning</b>	2,4,8 spectral and spatial	Default: 2 spectral x 1 spatial
<b>ROI</b>	Freely selectable multiple bands of interest	Minimum height of ROI is two 1-binned rows. Maximum frame rate is determined by the total number of rows included in the mMROI's
<b>Pixel operability</b>	99.993%	
<b>Image corrections</b>	Non uniformity correction Bad pixel replacement Automatic Image Enhancement (AIE)	One point NUC  AIE: Unified spectral calibration + corrected smile and keystone aberrations
<b>Sensor material</b>	CMOS	
<b>Sensor cooling</b>	Passive	
<b>Full well capacity</b>	90 ke-	
<b>Read-out modes</b>	IWR / ITR	
<b>Optics temperature</b>	Passive	
<b>Lens mount</b>	Custom mount	
<b>Fore lens FOV options</b>	12 deg 38 deg (default) 47 deg 51 deg 83 deg	Only the default lens is specifically designed for FX10. With other lens options, optical parameters may vary.
<b>Camera digital data output/control interface</b>	GigE Vision, CameraLink	
<b>Camera control protocols</b>	GenICam, ASCII	
<b>Power input</b>	12 V DC (+-10%)	
<b>Power consumption</b>	Max 4 W	
<b>Connectors</b>	Industrial Ethernet OR CameraLink 26-pin, 0.5" MDR	
<b>IP</b>	IP52	
<b>Dimensions (L x W x H)</b>	150 x 85 x 71 mm	Mounting surface option on three sides. Mounting kit adds 24 mm distance on mounting side.
<b>Weight</b>	1.3 kg	
<b>Storage temperature</b>	-20 ... +50°C (non-condensing)	
<b>Operating temperature</b>	+5 ... +40°C (non-condensing)	
<b>Relative humidity</b>	5% – 95% (non-condensing)	