



IMPROVE ACCURACY AND REDUCE COSTS

Specim FX17 camera is designed for industrial and laboratory use. It works in a line-scan mode, and collects hyperspectral data in the near-infrared NIR region (900 to 1700 nm).

Specim FX17 is best suited for:

- Food & feed quality
- Waste sorting
- Recycling
- Moisture measurement
- Threat detection, Security

FEATURES

- Spectral range of 900-1700 nm
- High spatial resolution of 640 pixels
- High image speed
527 FPS (full range) for GigE version
670 FPS (full range) for CameraLink version
- Free wavelength selection from 224 bands within the camera coverage
- Built-in image correction
- Unified spectral calibration between units
- GigE or CameraLink standard interfaces
- Easy mounting to industrial environment

SPECTRAL RESPONSE

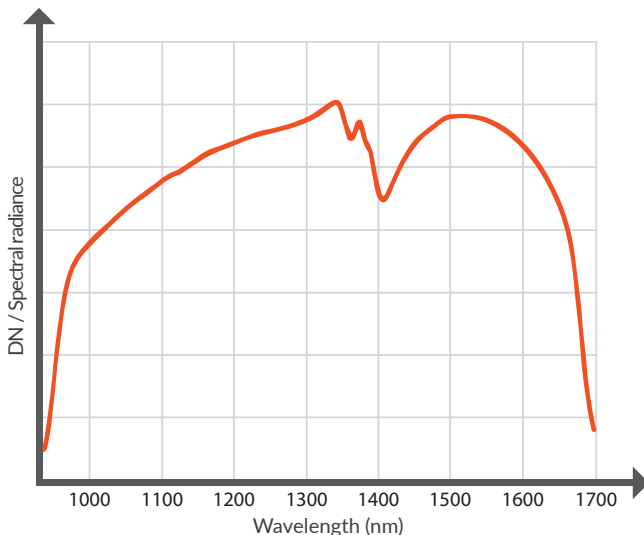

DIMENSIONS

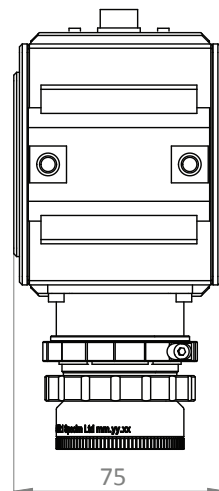
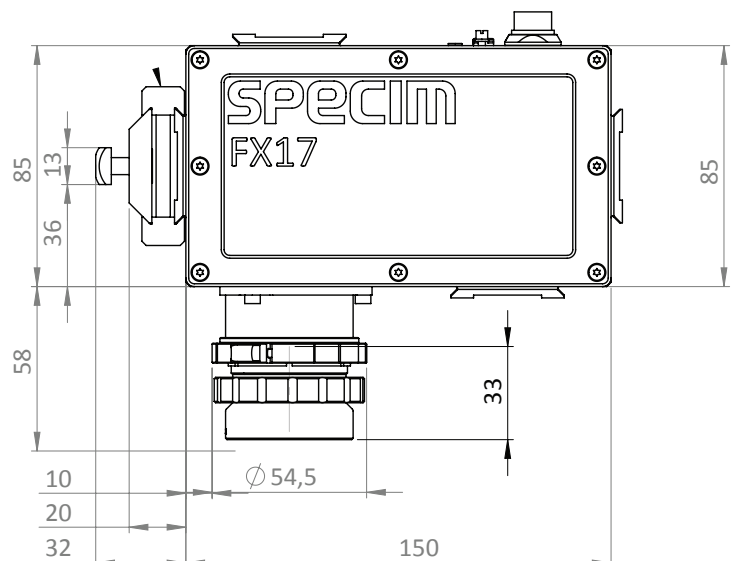

Spectral Range	900-1700 nm	
Spectral resolution (FWHM)	8 nm (mean)	
Spectral sampling/pixel	3.5 nm	
Spectral bands	224	With default binning
Numerical aperture	1.7	With default lens
Optics magnification	0.80	
Effective pixel size	18.7 μm	At fore lens image plane
Effective slit width	Physical width 42 μm . Projection on sensor 32 μm (M=1.3)	At fore lens image plane
Effective slit length	12.0 mm	At fore lens image plane
SNR @ max. signal	1000:1	
Bit depth	12	
Maximum frame rate	670 (FX17) 527 (FX17e) FPS full range	
Binning	1,2,4 spectral and spatial	Default: 2 spectral x 1 spatial
ROI	Freely selectable multiple bands of interest	Minimum height of ROI is two 1-binned rows. Maximum frame rate is determined by total number of rows between first row of first mROI and last row of last mROI and the total number of rows included in the mMROI's.
Pixel operability	99.5% Allowed clusters: Size 2-6 pixels: N/A Size 7-12 pixels: ≤ 6 Size 13-19 pixels: ≤ 2 Size 20-35 pixels: ≤ 1 Size > 35: 0	
Image corrections	Non uniformity correction Bad pixel replacement Automatic Image Enhancement (AIE)	One point NUC AIE: Unified spectral calibration + corrected smile and keystone aberrations
Sensor material	InGaAs	
Sensor cooling	TEC	
Full well capacity	1.44 Me-	
Read-out modes	IWR / ITR	
Optics temperature	Passive	Default is 20 degrees Celsius
Lens mount	Custom mount	
Fore lens FOV options	12 deg 38 deg (default) 53 deg 66 deg 75 deg 90 deg	Only the default lens is specifically designed for FX17. With other lens options, optical parameters may vary.
Camera digital data output/control interface	GigE Vision, CameraLink	
Camera control protocols	GenICam, ASCII	
Power input	12 V DC (+-10%)	
Power consumption	Max 24 W	
Connectors	Industrial Ethernet OR CameraLink (standard MDR 26-pin) Power – Fischer 12pin DBPLU1031Z012 130G	
IP	IP52	
Dimensions (L x W x H)	150 x 75 x 85 mm	Mounting surface option on three sides. Mounting kit adds 24 mm distance on mounting side.
Weight	1.56 kg	
Storage temperature	-20 ... +50 $^{\circ}\text{C}$ (non-condensing)	
Operating temperature	+5 ... +40 $^{\circ}\text{C}$ (non-condensing)	
Relative humidity	5% – 95% (non-condensing)	